

Installation and Operation Instructions

QCW (Quick Change Wasteboard) Frame - Foreman Version

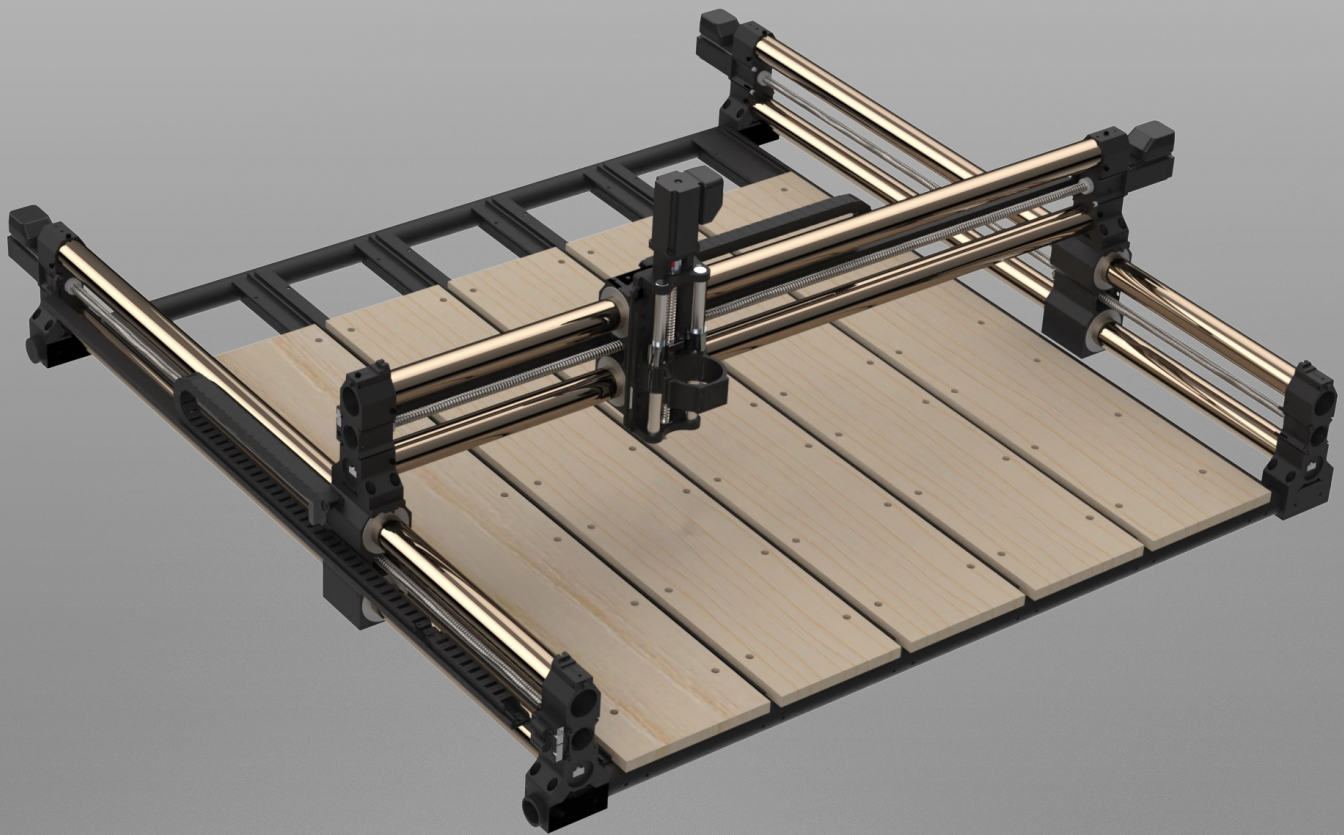

General Notes	3
Safety Rules	4-9
Description	10
Anatomy of the QCW Frame	11
Specifications (Foreman Version)	12
Assembly Instructions	13-19
Wasteboard Creation	20
Wasteboard Installation: Secure from Beneath	21
Wasteboard Installation: Secure from Above	22-25
Onefinity Warranty Policy	26-27
Notes	28
Contact Us	29



This manual serves to familiarize you with your Onefinity CNC machine and provide all necessary information required to operate the machine safely and professionally.

Please completely read this manual before the first commissioning of your machine. In order to minimize the risks of injury and/or material damages, please only commission the machine and the corresponding control when you are sure that you have completely understood these instructions!

Please contact us for any further questions. Please find our contact info on page 36 of these instructions.

Please always keep these instructions nearby the machine. You should always have them readily available when you want to look up something.

Please only use this machine according to its intended use.

We cannot be held liable for persons or material damages which are caused by using the machine other than the intended use, handling which does not comply with the common use of a CNC machine or if safety regulations are not obeyed

In case of improper maintenance ([refer to page 28](#)) and/or wrong operation of the individual components your warranty claims are omitted.

We reserve the right to perform future technical enhancements on the machine and its components.

General Instructions:

These operating instructions explain the Onefinity and the correct handling of the CNC system. Please read these operating instructions and accompanying documents in their entirety before commissioning of the system in order to become familiar with the characteristics and the operation of the product. The improper operation of the CNC gantry milling system can lead to damage to the product and property and can cause serious injuries, electric shock and / or fire. It is imperative to adhere to the safety instructions listed in these operating instructions at all times. Should you have any questions or concerns prior to initial use of the CNC system or the need for further information, do not hesitate to contact us prior to the commissioning of the CNC system.

Safety Instructions and Protective Measures:

(General Safety Warnings for the Use of Power Tools)

Work Area Safety

NOTICE: Keep work area clean and well lit. Cluttered or dark areas invite accidents.



Caution: Do not operate the power tool in explosive atmospheres, such as in the presence of flammable liquids, gases or dust. Power tools create sparks which may ignite the dust or fumes.

NOTICE: Keep children and bystanders at a distance while operating a power tool. Distractions can cause you to lose control and can result in accidents.



Caution: Operate the Onefinity only in interior spaces on a solid, horizontal table or workbench.

Electrical Safety:



Warning: Power tool plugs must match the outlet. Never modify the plug in any way. Do not use any adapter plugs with grounded power tools. Unmodified plugs and matching outlets will reduce the risk of electric defects and malfunctions.



Warning: Do not expose power tools to moisture. The power tool is only suitable for indoor use. Water entering a laser tool will increase the risk of electric shocks.

Personal Safety:



Caution: Stay alert, watch what you are doing and use common sense when operating a power tool. Do not use a power tool while you are tired and/or under the influence of drugs, alcohol or medication. A moment of inattention while operating a power tool may result in serious personal injury.

NOTICE : All persons who operate the power tool must have read and fully understood all relevant safety and operating instructions. Misunderstanding may result in personal injury.



Caution: Use personal protective equipment. Always wear eye protection. Protective equipment, such as a suitable dust mask or ear protection, reduces the risk of injuries.

NOTICE: Dress properly. Do not wear loose clothing or jewelry. Pin your hair above your shoulders so that it cannot get caught in the Ball Screws and linear guides or moving parts.



Caution: This tool is controlled by a computer. During operation, it cannot be controlled directly. Lack of caution or expertise as well as program errors can lead to unexpected movements.



Caution: Do not touch the insertion tools or motors as they can heat up significantly during operation.



Caution: Never place any parts of the tool or accessories in the mouth as this can lead to serious injuries.

Protective Measures:

The Onefinity has been constructed for advanced users and is only to be operated by technically skilled persons above the age of 16. The CNC gantry milling system as well as associated tools, small parts and electrical components are to be stored outside the reach of children. The operator is solely responsible for understanding and reading the machine user guide and all relevant operating instructions in their entirety. These documents should always be stored in immediate vicinity of the machine. The manufacturer's instructions concerning the CNC machine and the tools, such as the milling spindle, are to be adhered to. The CNC gantry milling system is only to be used in a technically perfect condition which is to be ensured prior to each operation. The emergency switch as well as, if applicable, additional safety devices, always need to be easily accessible and fully functional. The use of liquids with the machine, such as the application of a coolant pump, is prohibited as it can damage the electronics. The use of lubrication systems is allowed. Please take into consideration that in this case the MDF machine table is not used as its MDF panels can swell and, thus, be destroyed.

Use of the Power Tool:



Caution: Do not alter or misuse the tool. Any alteration or modification is a misuse and may result in serious personal injury.



Caution: Disconnect the plug from the power source before you make any adjustments, change accessories, or store the tool. Such preventative safety measures reduce the risk of starting the power tool accidentally.



Caution: Store idle power tools out of the reach of children and do not allow persons unfamiliar with the laser tool or these instructions to operate the power tool. Power tools are dangerous in the hands of untrained users.

NOTICE: Use the power tools, accessories etc. in accordance with these instructions, taking into account the working conditions and the work to be performed. Use of the power tool for operations different from those intended could result in a hazardous situation with high probability of superficial injury.

NOTICE: Do not reach into the area of the rotating insertion tools. The proximity of the rotating tools to your hand may not always be obvious.

NOTICE: Never use dull or damaged insertion tools. Sharp bits must be handled with care. Damaged bits can snap during use. Dull bits require more force to cut the tool, possibly causing the bit to break.

NOTICE: The speed and feed of the bit when carving, routing or cutting is very important. Always observe the recommended speed and feed for the particular bit.



Caution: If the workpiece or bit becomes jammed or bogged down, turn the power tool "OFF" by the switch. Wait for all moving parts to stop and unplug the tool, then free the jammed material. If the switch to the tool is left "ON", the tool could restart unexpectedly causing serious personal injury.

NOTICE: Do not leave a running tool unattended, turn power off. Only when tool comes to a complete stop and is disconnected from the mains it is safe.



Caution: Do not touch the bit or collet after use. After usage bit and collet are too hot to be touched with bare hands.

NOTICE: Do not allow familiarity gained from frequent use become commonplace. Always remember that a careless fraction of a second is sufficient to inflict severe injury.



Caution: When using the end mills, V-bits or cutters, always have the workpiece securely clamped. Never attempt to hold the workpiece with your hands while using any accessories. These tools can jam easily in the material, and can kickback, causing loss of control resulting in serious injury.

Care of the Power Tool:

NOTICE: Maintain the tools. Check for misalignment or binding of moving parts, breakage of parts and any other conditions that may affect the power tool's operation. If damaged, have the power tool repaired before use. Many accidents are caused by poorly maintained power tools.

Additional Safety Instructions



Caution: Depending on the application field of the machine (private or commercial), observe the applicable occupational safety and health, safety and accident prevention and environmental regulations.



Caution: Some dust created by cutting, milling or other construction activities contains chemicals known to cause cancer, birth defects or other reproductive harm. Some examples of these chemicals are: Lead from nonferrous metals with lead content, carbonate from carbon fiber, arsenic and chromium from chemically treated lumber. Your risk from exposures to these varies, depending on how often you perform this type of work. To reduce your exposure to these chemicals, work in a well ventilated area, and work with approved safety equipment, such as those dust masks that are specially designed to filter out microscopic particles.

Safely dispose of milling debris — recycle or safely dispose of milling debris and dust, keeping in mind flammability, (potential) spontaneous combustion, and chemical considerations. Even natural materials can have surprising implications for disposing of them, *e.g.*, walnut wood dust is allelopathic (inhibits plant growth) and an irritant to the skin and breathing tract and potentially poisonous to some animals in addition to the typical spontaneous combustion hazard which sawdust poses.

Personal Protective Equipment:

When working with the CNC gantry system, the operator has to wear at least the following personal protective equipment and has to be compliant with the below-mentioned safety aspects: - Safety goggles for protecting the eyes against flying chips etc. - Ear protection for protecting the ears against sound and noise. - No wearing of clothes which can get caught in the machine, such as ties, scarves, wide sleeves etc. Additionally, jewelry and especially long necklaces and rings are to be dispensed with. - Shoulder-length or longer hair is to be secured with a hairnet or a hat to prevent it from getting caught in the linear guides and / or rotating tools. Prior to all adjustments to the machine, its control or system-guided tools, such as the Milling Motor, the Drag Knife or the Hot Wire Cutter, the plug is to be disconnected from the power source. Never hold the workpiece to be processed with your hands. It is mandatory that the workpiece is securely fixed on the machine table. Otherwise there exists a high risk of injuries!

Emergency Stop Switch :

The emergency stop is located on the top of the Controller housing. In order to be able to intervene at all times, the emergency stop has to be positioned in a suitable place.





By pressing the emergency stop switch, the emergency stop is triggered. The control is interrupted. Additionally, the control software receives the signal to stop the operating process. The machine stops immediately.

ATTENTION! The emergency stop switch can only effect the stop of all components if these components are electronically connected with the emergency stop switch.

If you want to use a system-guided tool, such as a milling and drilling motor, that features a separate ON / OFF switch and that is NOT controlled via the PC, you have to make sure that it is expertly connected with the emergency stop switch. If you do not comply with these requirements, the system-guided tool will continue to run although you have activated the emergency stop switch leading to a high risk of personal injury and damage to property! If you have any questions, please do not hesitate to contact us!

Residual Risk:

Despite all safety precautions against the contact with rotating or hot tools and the protection from crushes, a residual risk remains due to a careless handling and automatic movements of the CNC system.

Symbol	Name	Explanation
	Symbol: Read manual	Alerts user to read manual BEFORE first commissioning
	Symbol: Wear ear protection	Alerts user to wear a hearing protector
	Symbol: Wear safety glasses	Alerts user to wear protective glasses
	General warning symbol	Alerts user to warning messages

Read the following carefully before operating the machine.

1. Keep the working area clean and ensure adequate lighting is available.
2. Do not wear loose clothing, gloves, bracelets, necklaces or ornaments.
3. Do wear face, eye, respiratory and body protection devices as indicated for the operation or environment.
4. Ensure that the power is disconnected from the machine before tools are serviced or any attachment is to be fitted or removed.
5. Never leave the machine with the power on.
6. Do not use dull, gummy or cracked cutting tools.
7. Ensure that the keys and adjusting wrenches have been removed and all the nuts and bolts are secured.
8. Hearing protection — ear plugs or muffs, for long jobs doubling up on ear plugs or muffs may be desirable. Hearing damage is cumulative and irreversible, so one should err on the side of caution
9. Use care when handling endmills, both to avoid being cut, and to avoid damaging them. Handling them with suitable gloves, or using a cloth to avoid contaminating them is recommended. Inspect them carefully before each use and ensure that they are securely held by the collet.
10. Never leave the machine running unattended/unsupervised.
11. Always inform someone before operating the machine and check in with them after successfully completing work.

Workspace:

The workspace needs to provide enough space around the Onefinity CNC for the machine to work comfortably and to be able to fully use its traveling paths. Additionally, a safe distance to possibly nearby positioned machines is to be maintained. The location of the machine as well as the workplace surrounding the machine has to be sufficiently illuminated.

As with all machinery, there are certain hazards involved with the operation and use of your machine. Using it with caution will considerably lessen the possibility of personal injury. However, if normal safety precautions are overlooked or ignored, personal injury to the operator may result. If you have any questions relating to the installation and operation, do not use the equipment until you have contacted your supplying distributor.

The Onefinity is a multifunctional CNC gantry milling system for the permanent and regular processing of wood, plastics and non-ferrous metals.

Thanks to the innovative design, how and where you carve is limitless! Feel like carving an intricate inlay into your dining table, no problem? Have a small shop where space is limited, Onefinity has been design to be quickly dismantled and stored!

With Fast Travel Precision Ball Screws, gone are the stretchy belts and high maintenance Lead Screws found on similarly priced machines. Hardened Steel Hollow Linear Motion Shafts means no more plastic wheels that require frequent adjustment and a powerful CNC controller with built in CAM software and HD Touch Display allows for operation without a computer!

The machine has three axes which are offset by 90° . This way, it is possible to travel to any point within the working space. Each axis is equipped with up to two stepper motors and stall homing. The stepper motors drive the movable axes elements via precision ball screws. The position of the axis is determined during the reference run (homing cycles), at the beginning of the job, with the aid of the stall homing. The machine table may consist of any solid flat surface big enough to mount the Rails and Controller. The Onefinity consists of the following, sometimes optional, components: - Onefinity Woodworker, Machinist; - electronic control unit in a separate aluminum housing, Z-Slider, Wire harness and Hardware.

Anatomy of the QCW Frame

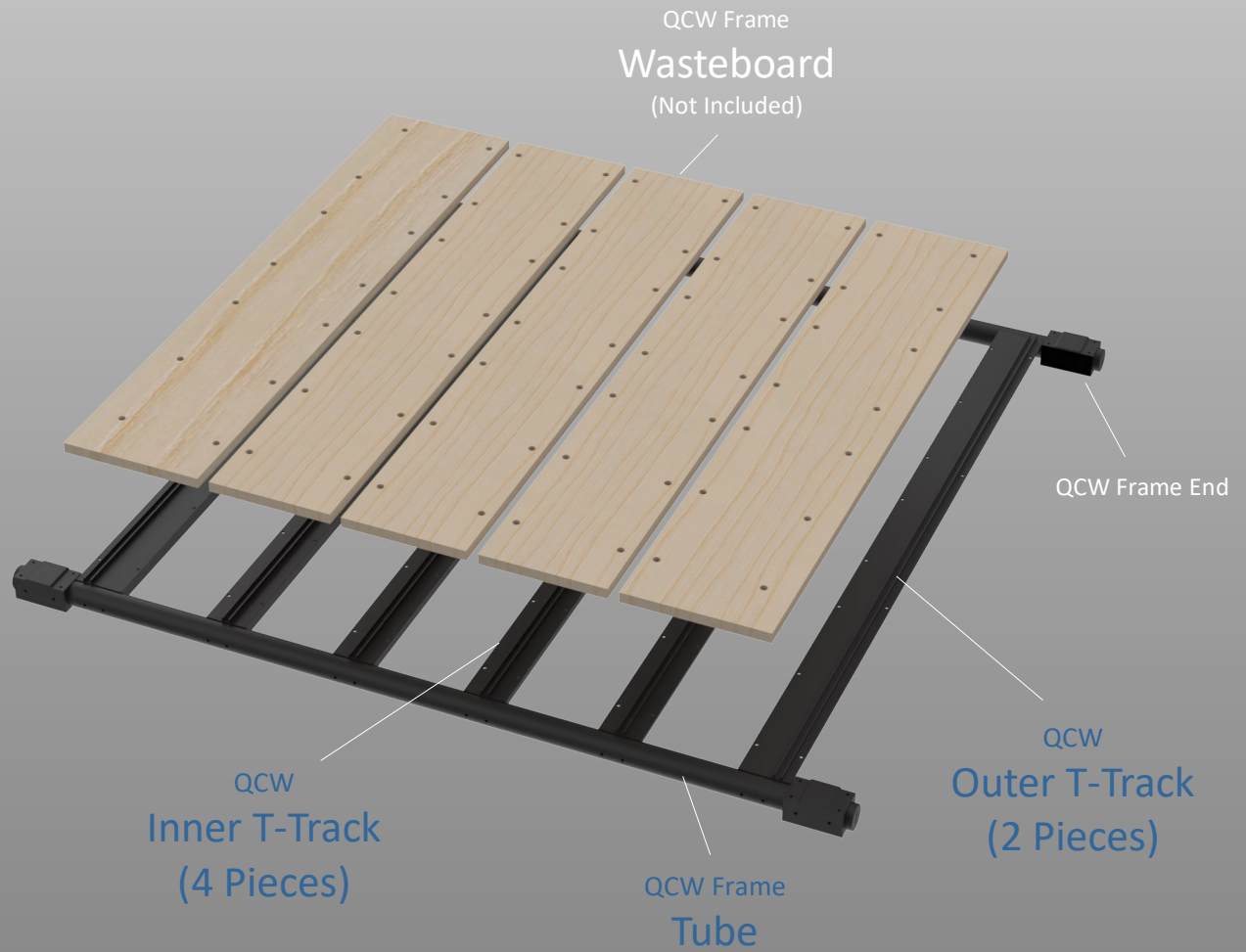

Specifications (Foreman Version)

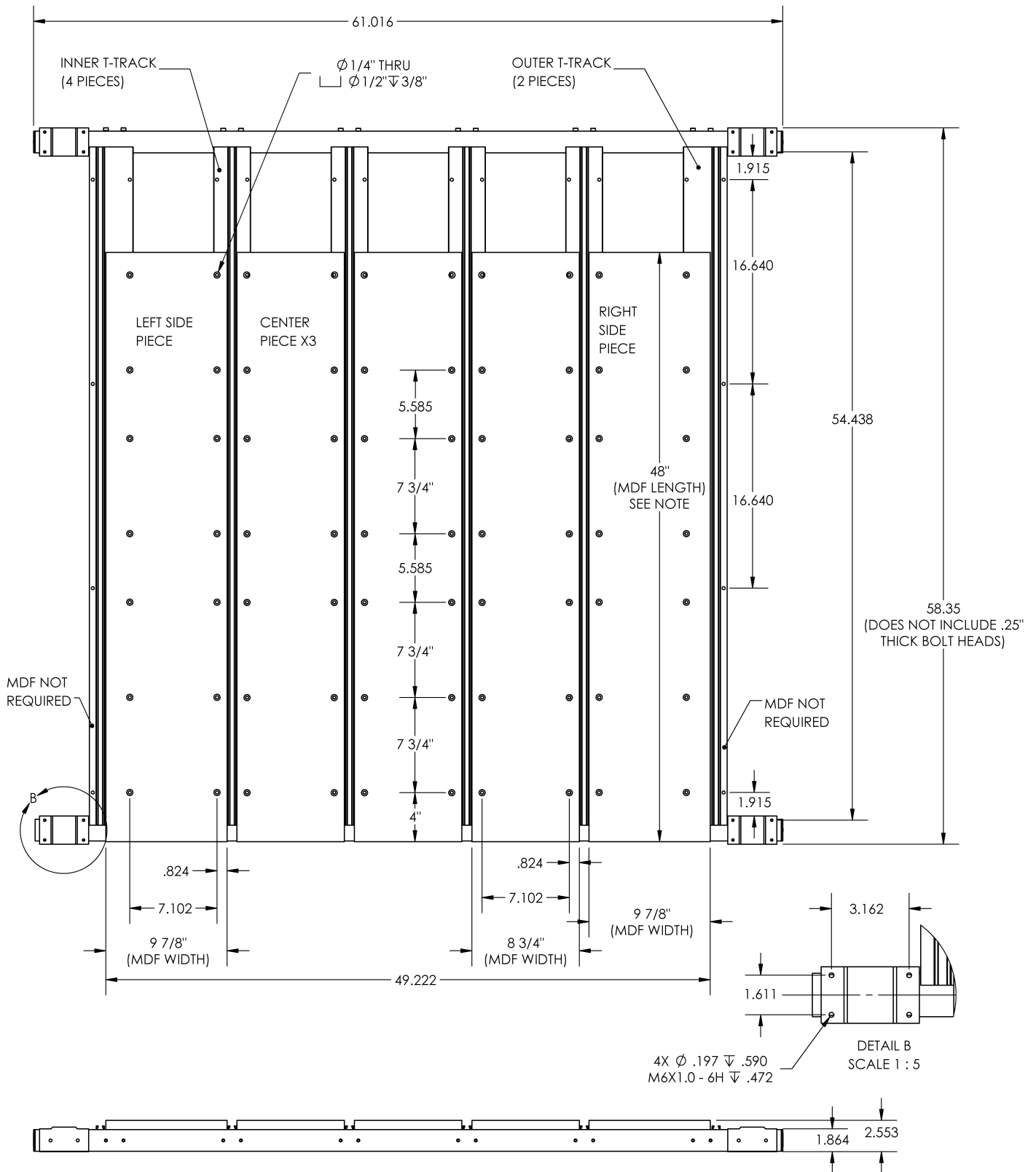

NOTE: LENGTH OF MDF CAN BE MODIFIED TO BE LONGER OR SHORTER TO SUIT SPECIFIC NEEDS.

QCW FRAME (FOREMAN)

NOTE: MDF WASTEBOARD NOT INCLUDED



General Disclaimer:

While Onefinity has made every effort at the time of publication to ensure the accuracy of the information provided herein, product specifications, configurations, system/component/options availability are all subject to change without notice. Product design specifications and colours are subject to change without notice and may vary from those shown. Errors and omissions excepted. Images displayed are for illustration purposes only. The images are intended to help illustrate the product and its functions and are not indicative of actual relative differences.

QCW Frame Assembly Instructions

The following instructions detail how to assemble the QCW Frame and install your Onewfinity CNC Machine. Please read these entire instructions carefully. If you have any problems or do not understand these instructions please contact us at support@onewfinitycnc.com or 1-888 717 4242 for further assistance.

For step-by-step instructional video's and how-to's please visit our Youtube page at: <https://www.youtube.com/onewfinitycnc>. **Note:** It is highly recommended that you view all of our assembly videos prior to attempting to assemble your Onewfinity machine.

Step 1: Set the QCW Frame Tube Assemblies (Red Arrows) on a bench or solid surface and place them close to where you would like them to be installed. Fasten the first Outer T-Track Extrusion (Blue Arrow) to the first QCW Frame Tube Assembly (Red Arrow) using the QCW Frame Assembly Bolts (Green Arrow). **Note:** Do not fully tighten the Bolts yet. You'll tighten them at the end of the next step

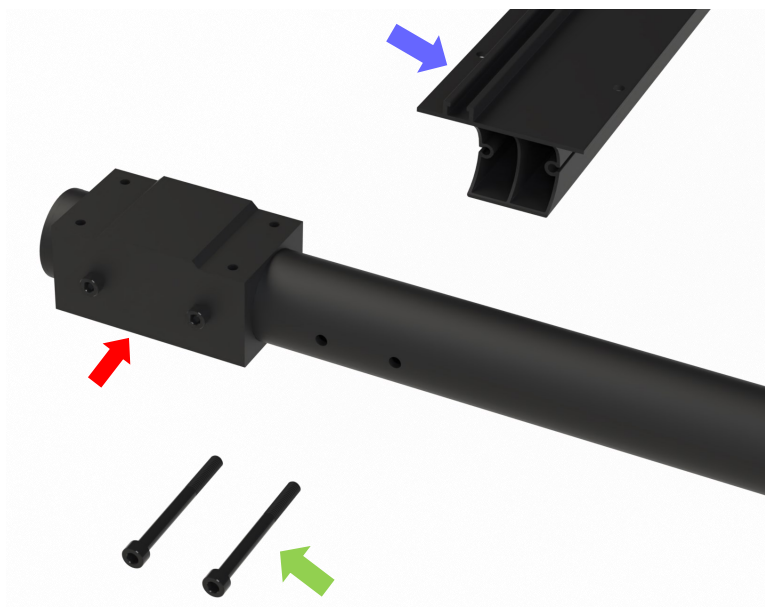

Step 2: Attach the rest of the T-Track Extrusions to the QCW Frame Tube Assemblies using the remaining QCW Frame Assembly Bolts. **Note:** To make the assembly process easier, wait until you have all the T-Track Extrusions attached before fully tightening the QCW Frame Assembly Bolts.

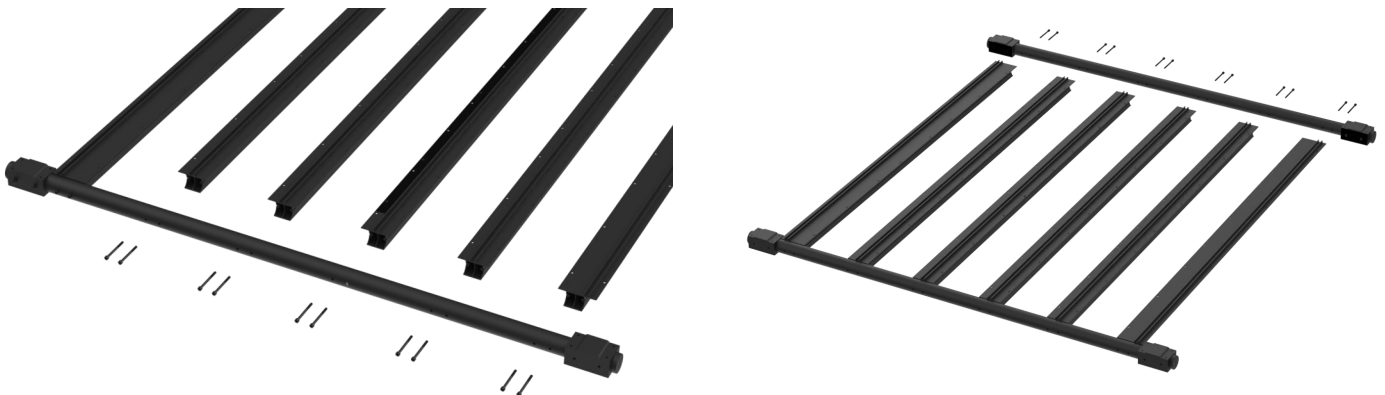

Assembly Instructions

The following instructions detail how to install your Onewfinity CNC Machine. Please read these entire instructions carefully. If you have any problems or do not understand these instructions please contact us at support@onewfinitycnc.com or 1-888 717 4242 for further assistance.

For step-by-step instructional video's and how-to's please visit our Youtube page at: <https://www.youtube.com/onewfinitycnc>. **Note:** It is highly recommended that you view all of our assembly videos prior to attempting to assemble your Onewfinity machine.

Step 1: Set Y-Rails (Red Arrows) on the QCW Frame Ends as shown below. **Note:** If you have a "Secure from Beneath" version, please go to section "Wasteboard Creation and Installations" and attached your waste before proceeding.



Step 2: Slide the Gantry assembly (Green Arrow) all the way to the front until it's tight to the Rail End (Blue Arrow). See below pictures. (Note: you can also turn the ball screw to get the Gantry Assembly to move to the front). **Important:** Make sure they are all the way to the front!

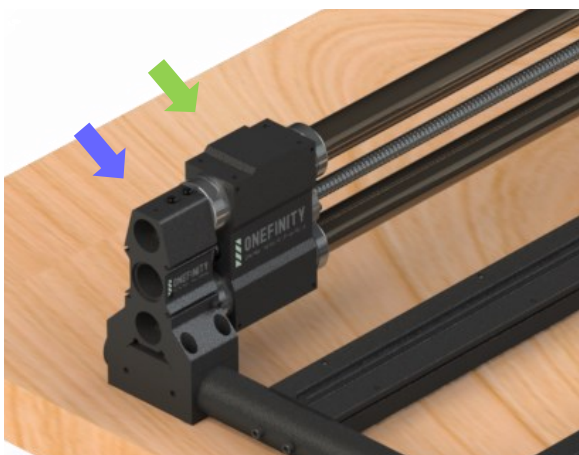

Assembly Instructions

Step 3: Place the X-Rail (Green Arrow) on the Y-Rails Gantry Blocks (Blue Arrows)

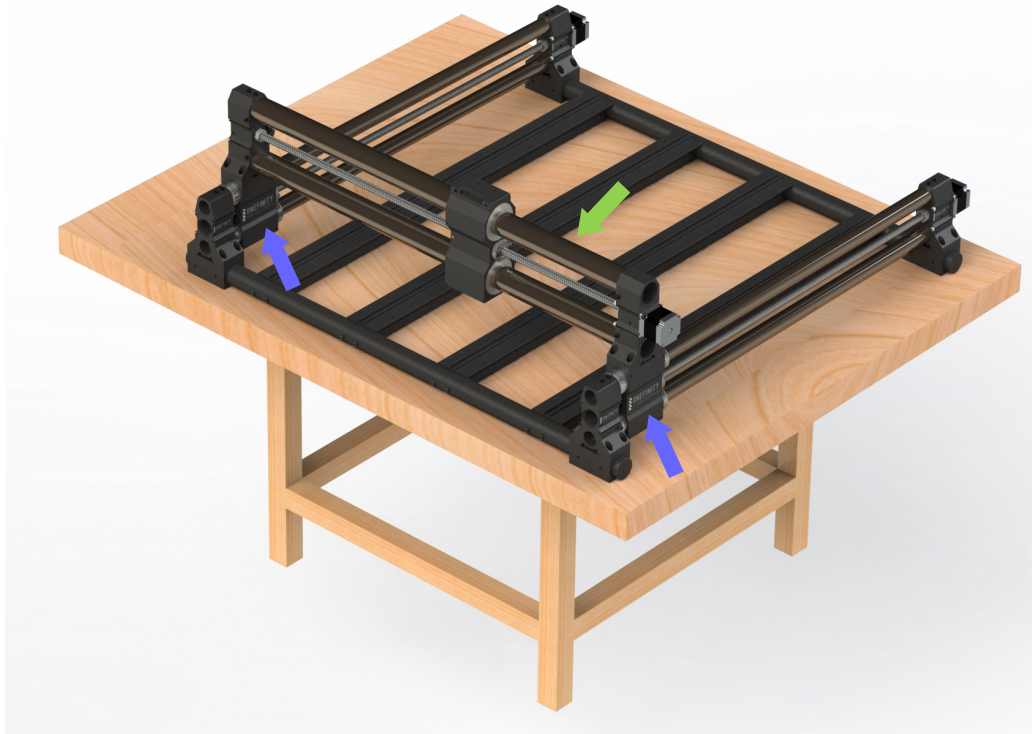

Step 4: Adjust Y-Rails (Red Arrows) until the Gantry Assemblies (Green Arrows) are flush with X-Rail Ends (Blue Arrows). **Note:** It is important that these parts are flush with each other before fastening together.

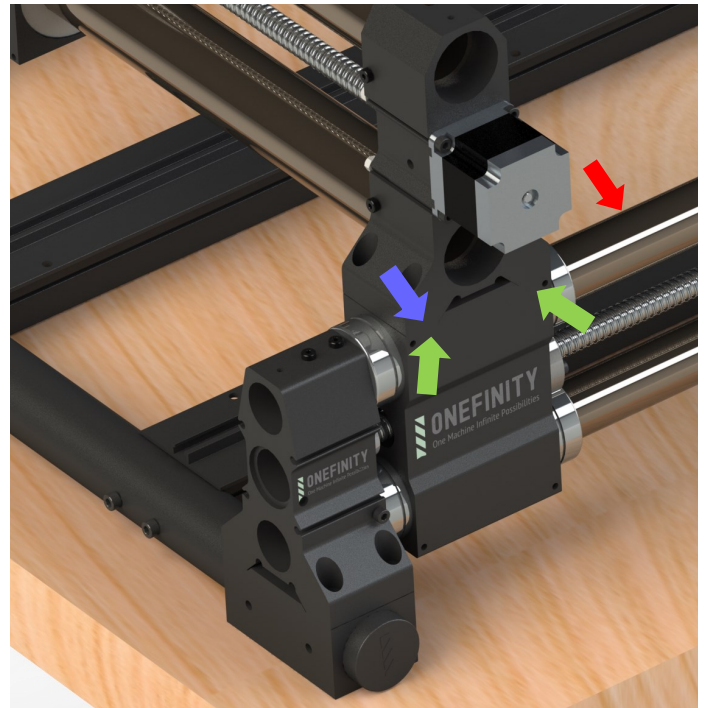
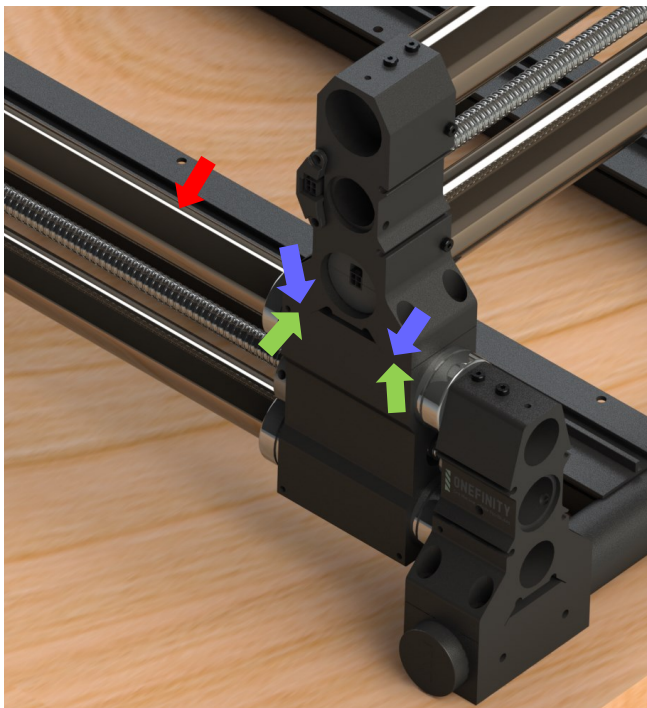

Assembly Instructions

Step 5: Once you have ensured the Y-Axis Gantry Blocks and X-Axis Rails Ends are flush, fasten the front of the X-Rail to the Y-Axis using four (4) X-Rail Mounting Screws (Blue Arrows)

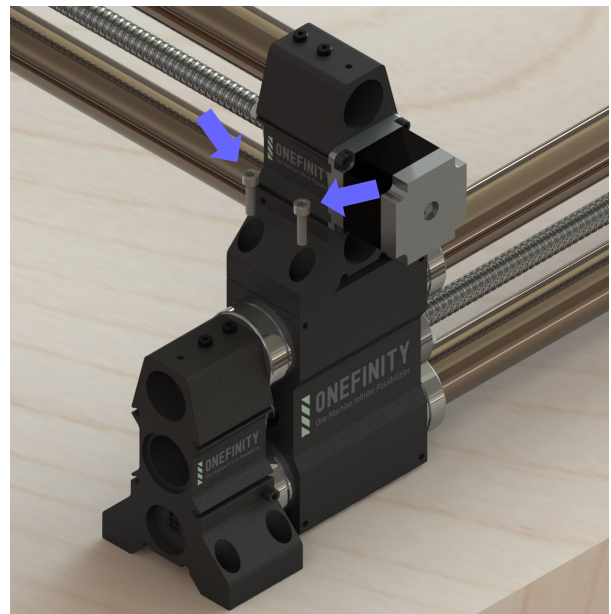
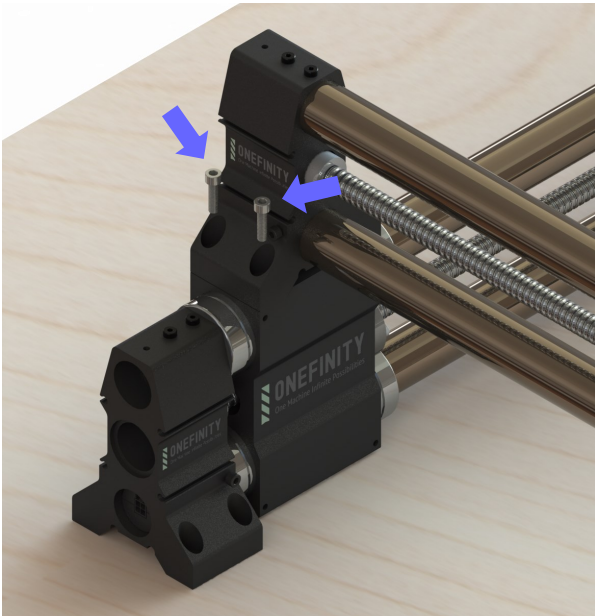

Step 6: Fasten the back of the X-Rail to the Y-Axis using the remaining four (4) X-Rail Mounting Screws (Green Arrows)

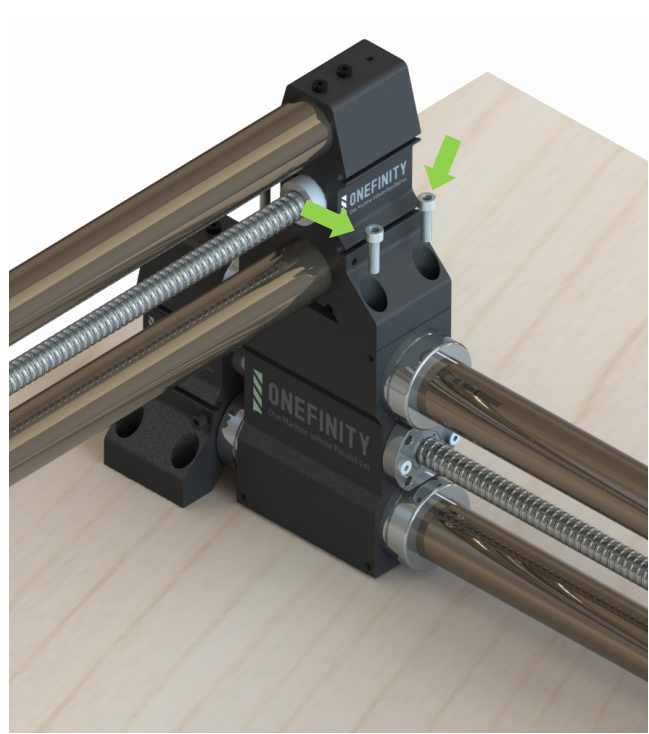
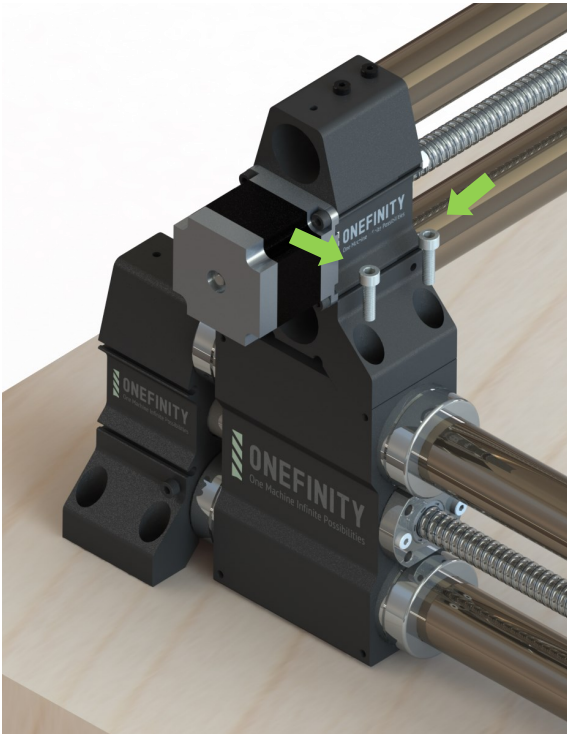

Assembly Instructions

Step 7: Fasten the front of the Y-Rails to your QCW Frame using only one (1) Y-Rail Mounting Screw per side (Green Arrow). You will use the remaining screws later.



Step 8: After fastening the front Y-Rails, push the X-Rail to the back of the machine as shown below.



Assembly Instructions

Step 9: After moving the X-Axis all the way to the back, fasten the back of the Y-Rails to your QCW Frame using only one (1) Y-Rail Mounting Screw per side (Green Arrow).

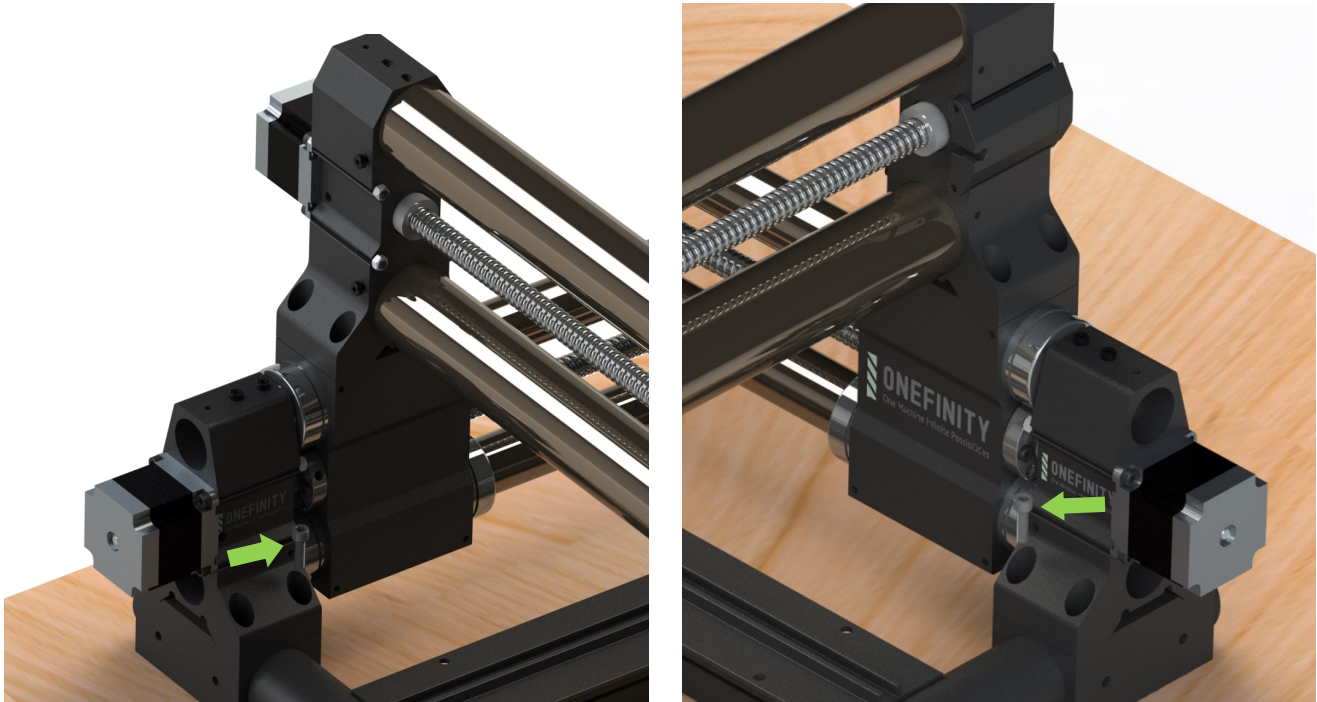

Step 10: We will now finish fastening the front Y-Rails. Push the X-Rail all the way to the front again, finish fastening the Y-Rails to the QCW Frame using another three (3) Y-Rail Mounting screws per side (Green Arrow).

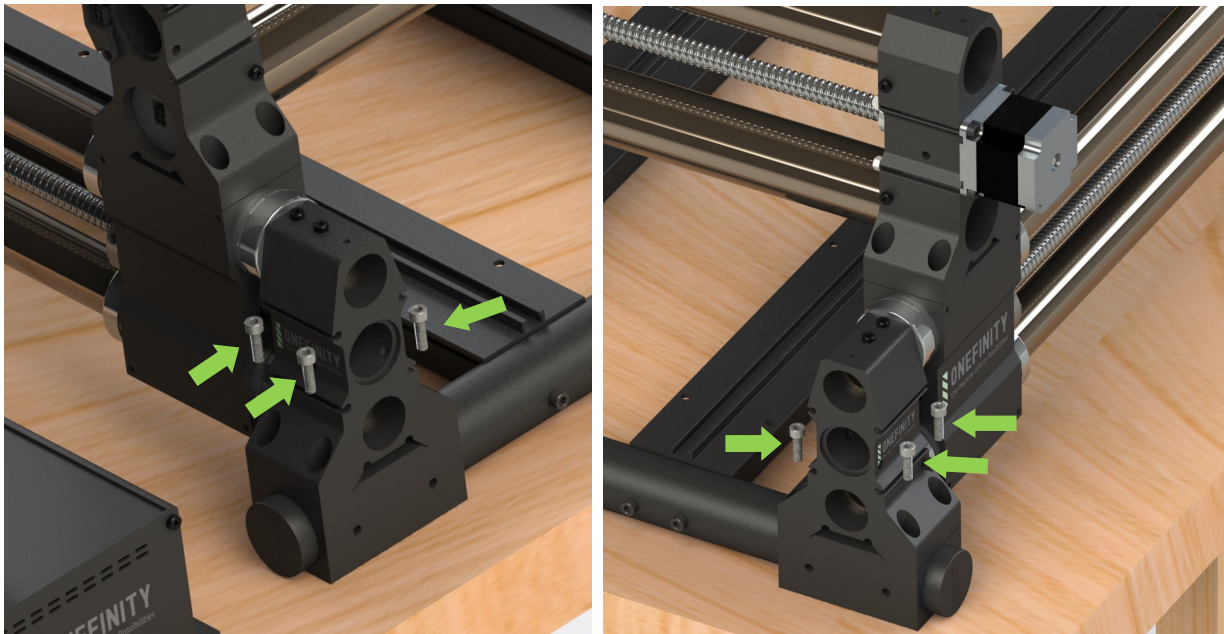

Assembly Instructions

Step 11: Repeat steps 14 and 15 to jog the Y-Axis until the X-Rail is to the back of the machine again. Finish fastening the Y-Rails to the QCW Frame using the remaining three (3) Y-Rail Mounting Screws per side (Green Arrows).



Step 12: Congratulations, you have now finished assembling you QWC. To finish assembling your Onefinity please follow the steps outlined in the Onefinity Owners Manual which can be found on the support page of our website. www.onefinitycnc.com/support

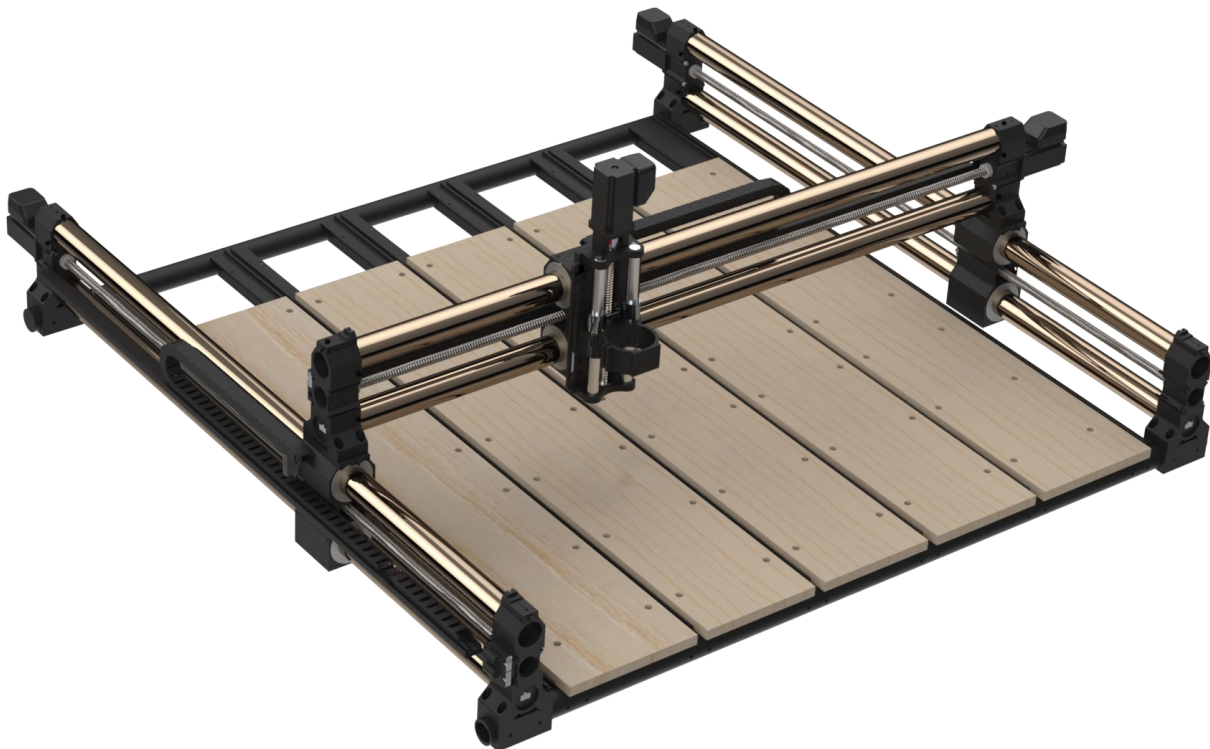

Wasteboard Creation

A wasteboard is a disposable work surface that will be mounted atop your Onefinity's permanent table. Having a wasteboard is an important part of a CNC and makes using the Onefinity more enjoyable as leveling and workholding becomes easier. The wasteboard is typically MDF and protects the table from damage as well as being an expendable surface. From time to time your wasteboard will need to be surfaced. That means using a spoilboard cutter to clean up any gouges or cuts and make the board flat and parallel to X and Y axis travel. The unique design of the Onefinity allows you to create/use any style Wasteboard you desire.

Note: The minimum recommended wasteboard thickness is $\frac{3}{4}$ ". This allows you to achieve maximum Z-Travel while still having a thick enough surface to attach/clamp your work piece. This thickness will also give you the opportunity to perform several surfacing operations before needing to be replaced.

Preparing your Wasteboard: Your wasteboard is ideally made from MDF strips. Below is diagram showing how to maximize a 4' x 4' sheet. Start by cutting the length and width to 48". Take the 48" piece and cut 2 pieces to a width of $9\frac{7}{8}$ " and 3 pieces to a width of $8\frac{3}{4}$ ".

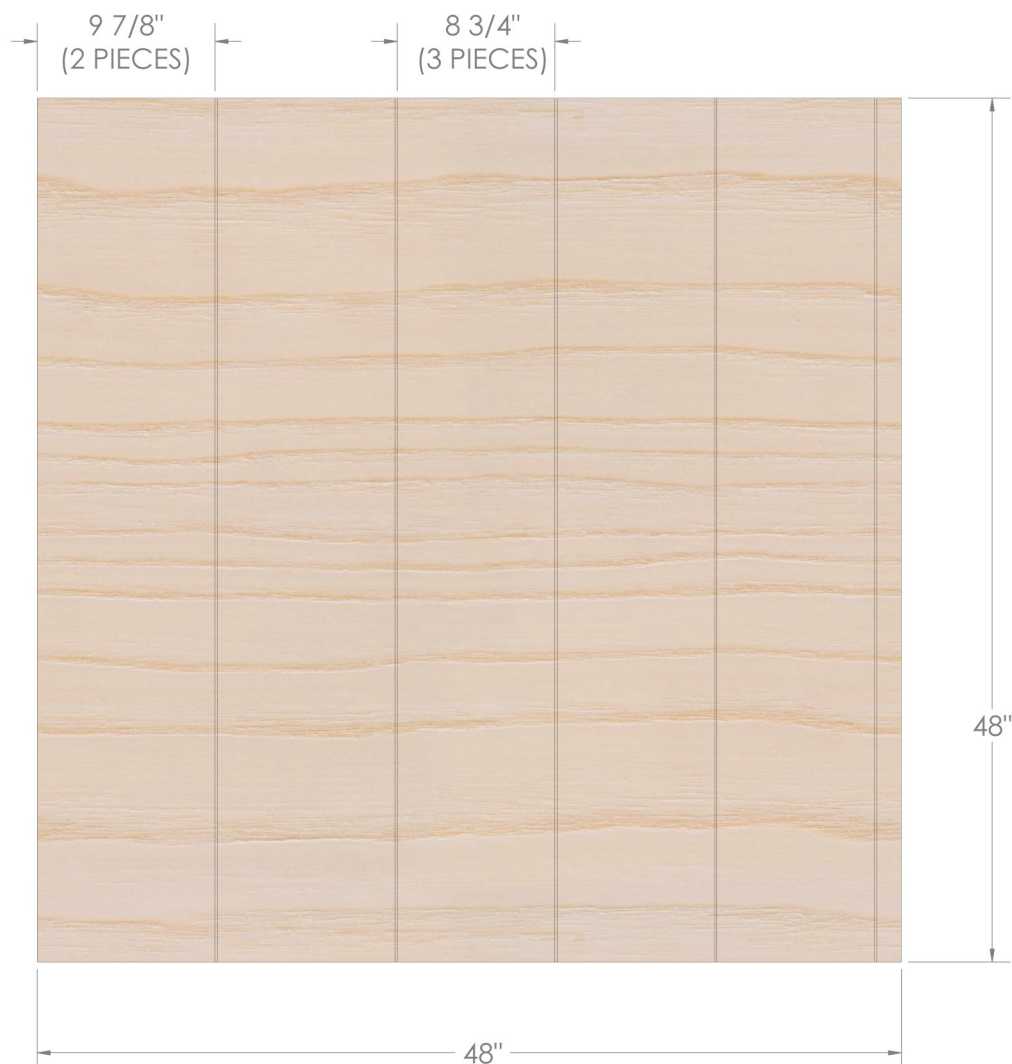

Waste Board Installation: Secure from Beneath

QCW Frame Secure from Beneath: Before attaching your Onefinity CNC.

After you have assembled your QCW Frame and before you attach your Onefinity CNC you can attached the Waste Board. **Important Note:** Due to the size and weight of the Foreman, it is highly recommended that the Onefinity CNC be removed when changing your Waste Board

Step 1: Lay the Waste Board strips out on your table or solid surface and position the QCW Frame over top.



Step 2: Ensure the wasteboard is flush with the front of QCW Frame Tube and secure your wasteboard using the supplied screws. **Very Important Note:** Set the torque on your drill to low and finish tightening the screws with a hand screw driver. If your drill torque is set too high the screws may strip!

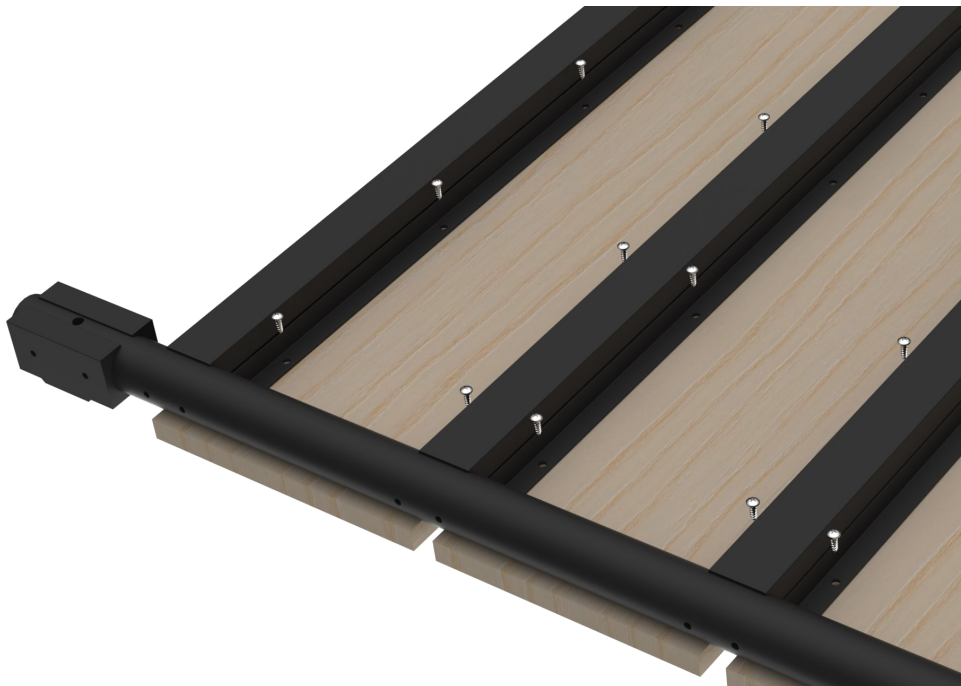

Wasteboard Creation: Secure from Above

QCW Frame Secure from Above:

After you have assembled your QCW Frame and installed your Onefinity CNC you can attached the wasteboard. Below are steps illustrating how to create and install you Secure from Above Wasteboard.

Step 1: After you have cut your 3/4" MDF per the above instructions (Perparing your Wasteboard) you will need to drill and counter bore holes in order to fasten your Wasteboard to your "Secure from Above QCW Frame.

Tools required:

- Drill
- 1/16" Drill Bit (Not Shown)
- 1/4" Drill Bit
- 1/2" or 5/8" Diameter Forstner Bit
- Hammer
- MDF Wasteboard Strips
- Pencil
- Tape Measure



Step 2: Using your Tape Measure and Pencil, mark the holes shown below on your 3 Centre Pieces. After you have marked the hole locations, take your Forstner Bit and Hammer and punch a centre hole. Do this in all 14 locations.

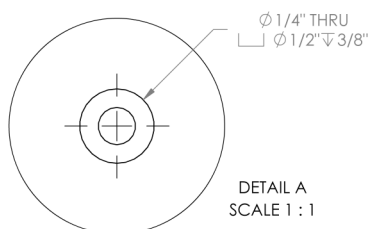
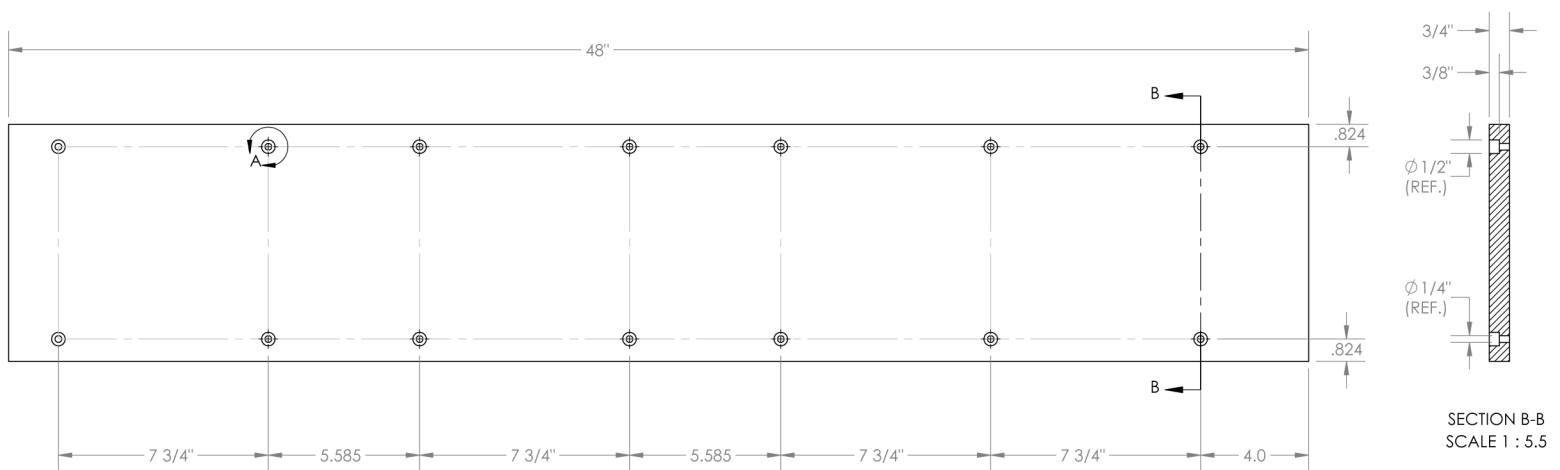

CENTER PIECE (X3)

Wasteboard Creation and Installations

Step 3: Using your Tape Measure and Pencil, mark the holes shown below on your Left Side Piece. After you have marked the hole locations, take your Forstner Bit and Hammer and punch a centre hole. Do this in all 14 locations.

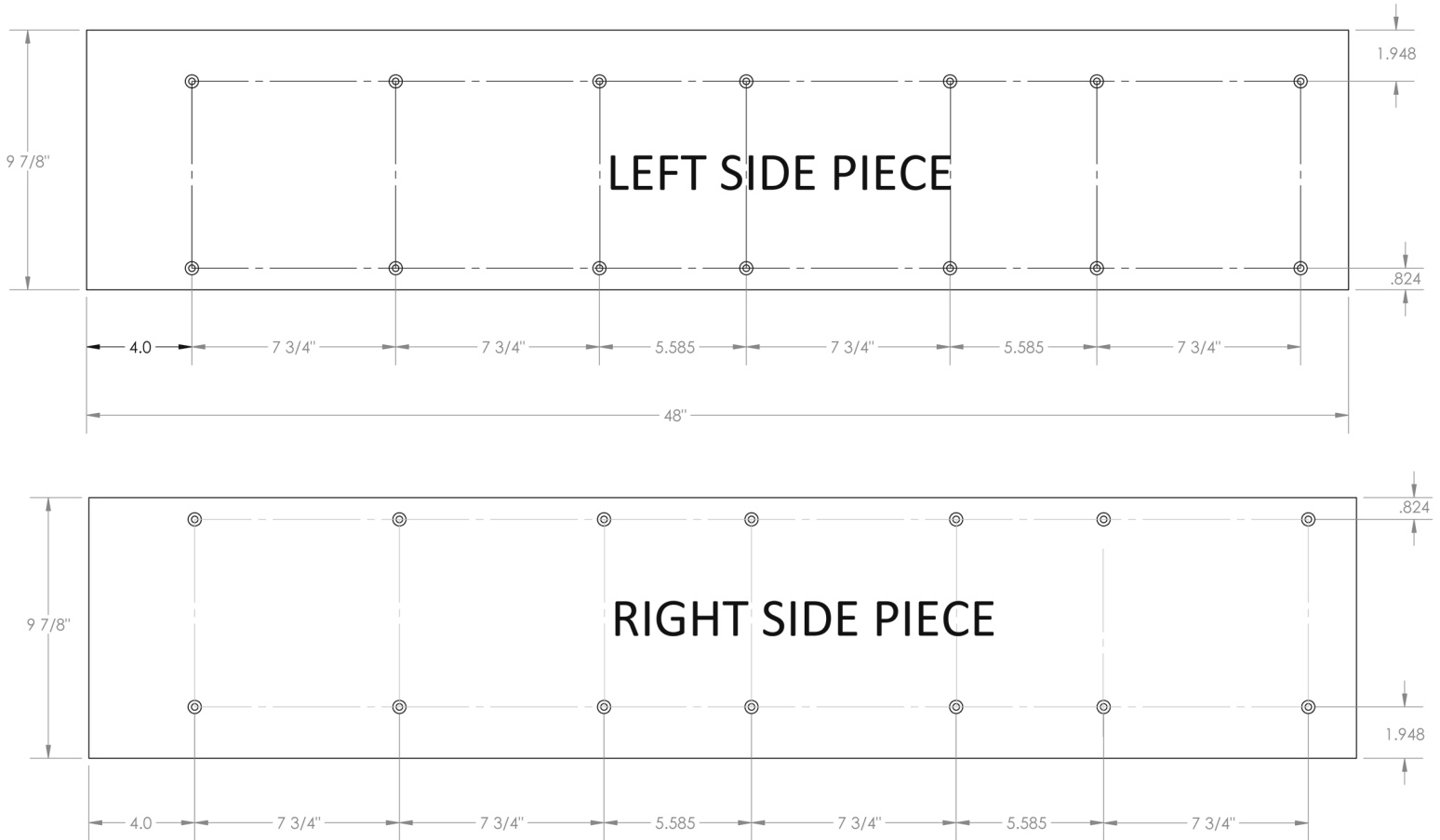

Step 4: Insert your Forstner Bit into your drill and counter bore holes in the locations you centre punch in step 3. **Important Note:** Counter bore to a depth of 3/8"



Wasteboard Creation and Installations

Step 5: After counter boring your MDF the wasteboard strips should look like this.



Step 6: Using a 1/16" Drill Bit, drill through holes in the centre of the counter bored holes.

Note: Performing this step helps to minimize chipping of the MDF.



Step 7: Flip over the Wasteboard strip so the counter bore holes are facing down. With the wasteboard strip flipped over, drill open the 1/16" holes you drilled in step 6 using a 1/4" Drill Bit.



Wasteboard Creation and Installations

Step 7: After counter boring and drilling the holes in all the wasteboard pieces, use an 1/8" Hex key and attach the wasteboard strips to your QCW Frame using the supplied bolts and washers.

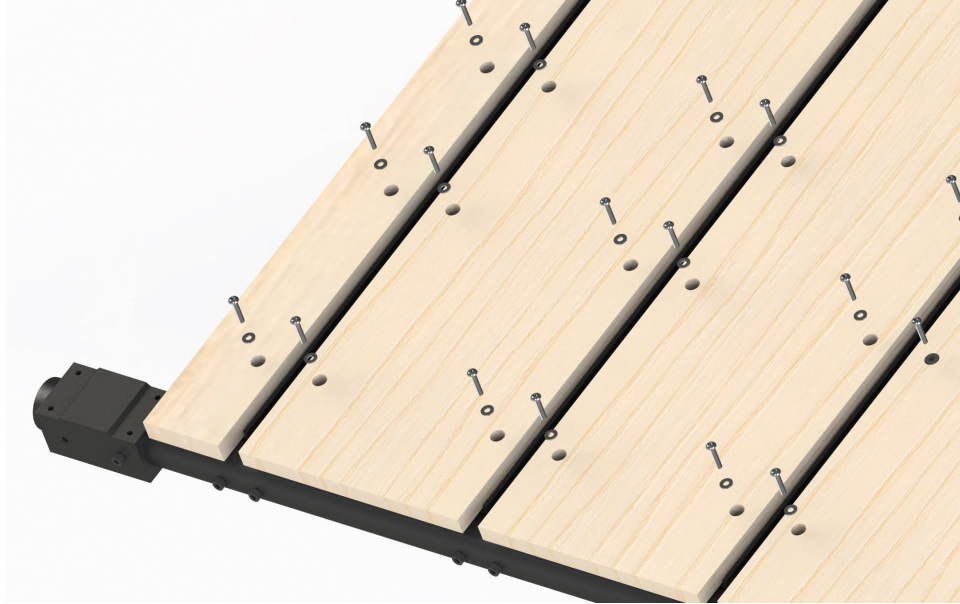

Congratulations! You have now completed installing your "Secure From Above" Wasteboard!

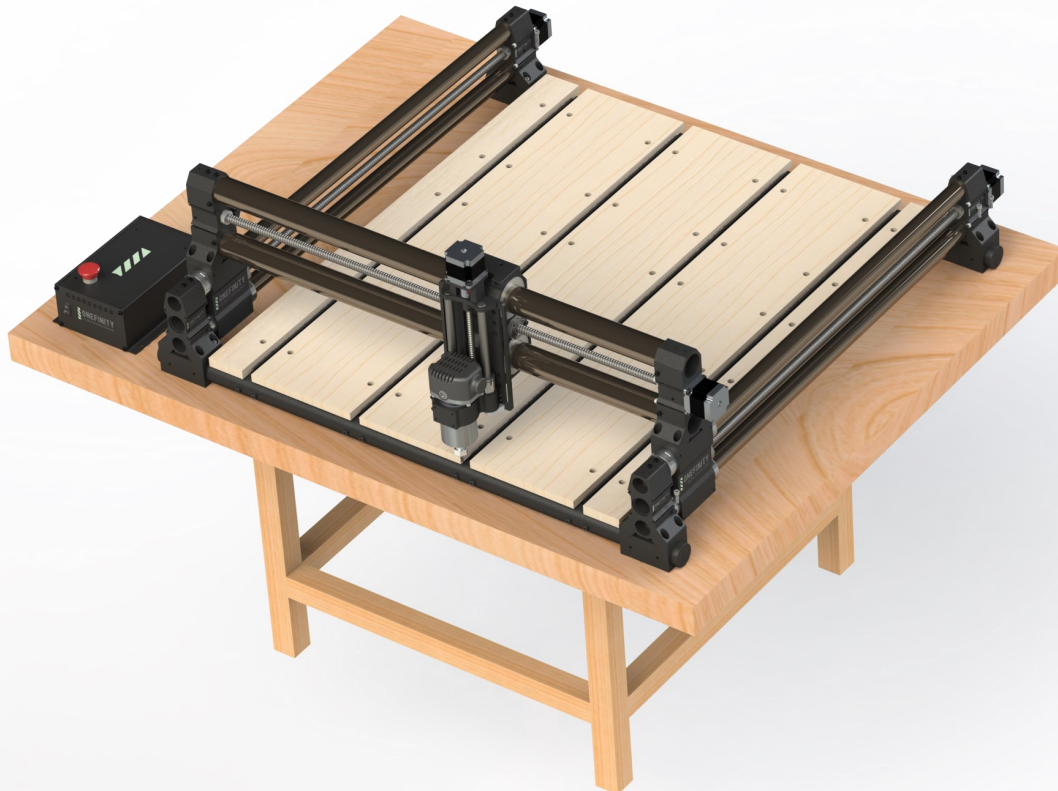

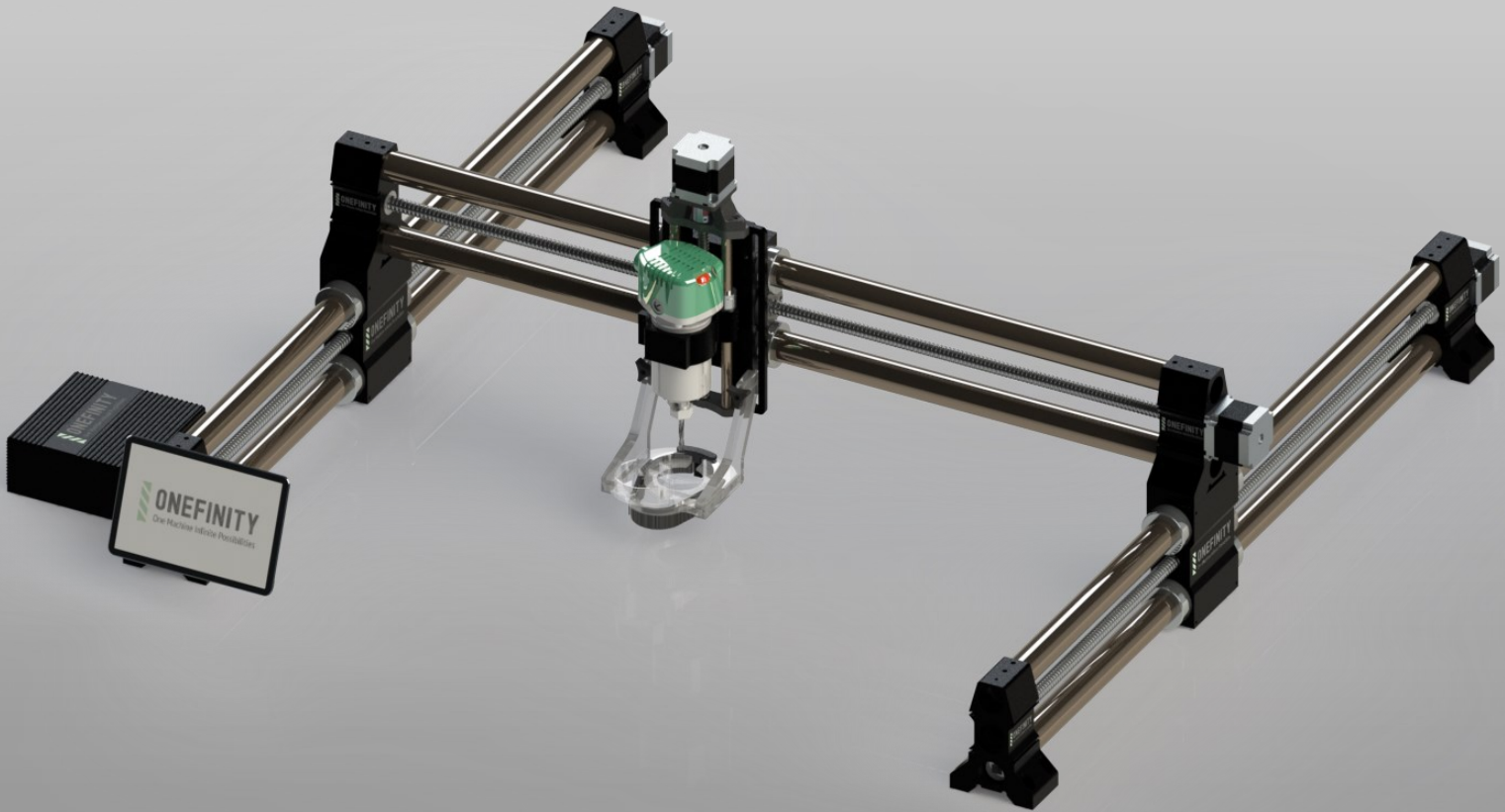

ONEFINITY 12-MONTH LIMITED WARRANTY

PLEASE SEE REVERSE SIDE FOR DE-
TAILS

IMPORTANT! SAVE THE ORIGINAL SHIPPING MATERIALS FOR WARRANTY REPAIR

1. THIS WARRANTY GIVES YOU SPECIFIC LEGAL RIGHTS, AND YOU MAY HAVE OTHER RIGHTS THAT VARY FROM PROVINCE TO PROVINCE OR STATE TO STATE. OTHER THAN AS PERMITTED BY LAW, KIRBRE DOES NOT EXCLUDE, LIMIT OR SUSPEND OTHER RIGHTS YOU MAY HAVE. FOR A FULL UNDERSTANDING OF YOUR RIGHTS YOU SHOULD CONSULT THE LAWS OF YOUR PROVINCE OR STATE.

2. ACCEPTANCE OF THE EXCLUSIVE REPAIR AND REPLACEMENT REMEDIES DESCRIBED HEREIN IS A CONDITION OF THE CONTRACT FOR THE PURCHASE OF EVERY ONEFINITY CNC MACHINE. IF YOU DO NOT AGREE TO THIS CONDITION, YOU SHOULD NOT PURCHASE THE PRODUCT.

3. **ONEFINITY LIMITED WARRANTY.** Kirbre Enterprises Inc. (“**Kirbre**”, “**us**”, “**we**”, “**our**”) warrants the Onewfinity CNC machine (“**Onewfinity CNC**”) to be free from defects in design, workmanship and materials for a period of twelve (12) months from the original shipment date to the end-user purchaser when used in accordance with Kirbre’s published guidelines. Our published guidelines include but are not limited to information contained within Onewfinity CNC Owner’s Manual, our technical specifications, and any service communication provided by us. Warranty repairs may require you to install a replacement part provided by us or, at our discretion, require you to return the Onewfinity CNC for warranty service. The Onewfinity Limited Warranty is limited to the repair of the Onewfinity CNC with new or refurbished parts for any defect in material or workmanship and when applicable, at our discretion, to the exchange of your warranted Onewfinity CNC for a new or refurbished Onewfinity CNC of equal or greater value.

4. **VERIFICATION AND RETURN.** Such repair or replacement is subject to verification of the defect or malfunction and proof of purchase as confirmed by showing the Onewfinity CNC model number on the original dated sales receipt. If we conclude shipping is necessary, we will provide you with a shipping label. You are solely responsible for all shipping and handling fees as well as V.A.T., import duties, any applicable taxes, and other related fees (collectively “**Import Costs**”) you may be required to pay when shipping the Onewfinity CNC to us, and we will not assume responsibility for any payments relating thereto (including but not limited to brokerage fees, storage fees, etc.). You are solely responsible for any damage to the Onewfinity CNC during shipping, so please ensure packaging of the Onewfinity CNC follows the instructions provided in Section 3, “Returns”, of our Shipping and Returns Policy. Any additional costs incurred for transportation or removal of your Onewfinity CNC are not covered by this Limited Warranty. For all valid warranty repairs, Kirbre will pay for the return shipping costs to the country or region where Kirbre originally shipped the Onewfinity CNC (“**Shipping Destination**”) to the end-user purchaser, excluding V.A.T., import duties, any applicable taxes, and other related fees. If you seek warranty service from a country or region that is not the original Shipping Destination, you will be responsible for the payment of all shipping costs in addition to any applicable custom duties, V.A.T., any applicable taxes, and other related fees.

5. **WARRANTY LIMITATIONS AND EXCLUSIONS.** This warranty does not cover repairs for:

- Onewfinity CNC used for commercial purposes or used in any manner for which the product was not intended, such as use in rental or contract trade.
- Onewfinity CNC damaged as a result of incorrect or inadequate maintenance or care.
- Damages resulting from misuse, abuse, negligence, accidents, shipping damage, fire, earthquake or other external cause.
- Damages that are the result of normal wear and tear or otherwise due to the normal aging of the Onewfinity CNC parts.
- Damages incurred during transportation.
- Damages incurred during assembly or maintenance.
- Damages that are determined to be from repairs, upgrades and expansions made by third parties not authorized by Kirbre.
- Damages resulting from modifications made to alter the functionality or capability without Kirbre’s written authorization.

6. WARRANTY VOID. Without limiting the generality of the foregoing, this warranty will be void, and no warranty coverage will be provided for any damage caused if you do any of the following:

- a. Install any firmware or software in the Onefinity CNC, its electronics or computer components that are not specifically issued or authorized by Kirbre;
- b. Make any change or modification to the electronics or computer components of the Onefinity CNC;
- c. Attach any peripherals or accessories to the Onefinity CNC or its electronics or computer components that have not been specifically issued or authorized in writing by Kirbre;
- d. Use or attempt to use the Onefinity CNC and/or its electronics or computer components to control or move any device or object not specifically issued or authorized in writing by Kirbre;
- e. If any serial number has been removed or defaced from the Onefinity CNC; or
- f. If Kirbre receives information the Onefinity CNC has been stolen or illegally acquired.

In addition, we will not be liable for any damages or losses caused or resulting from the use or attempted use of firmware, software, peripherals or accessories that have not been specifically issued by us to be used with the Onefinity CNC, its electronics or computer components.

7. Obtaining Service. To obtain warranty service, first email Onefinity at support@onefinity.com and include your order number, contact info along with a brief explanation of the issue you are having. Once your email is received someone on our team will contact you by telephone to conduct a warranty diagnosis. You may be required to provide pictures and/or video of the claimed defect. If we cannot determine from the warranty diagnosis whether your Onefinity CNC qualifies for warranty repair we may require you to return the Onefinity CNC to Kirbre for further evaluation.

IN NO EVENT SHALL KIRBRE, ITS DIRECTORS, OFFICERS, EMPLOYEES, AGENTS, CONSULTANTS, LICENSORS AND THIRD PARTY SUPPLIERS BE LIABLE FOR ANY INCIDENTAL, SPECIAL, CONSEQUENTIAL OR PUNITIVE DAMAGES, OR FOR ANY COSTS, ATTORNEY FEES, EXPENSES, LOSSES OR DELAYS ALLEGED TO BE AS A CONSEQUENCE OF ANY DAMAGE TO, FAILURE OF, OR DEFECT IN ANY PRODUCT INCLUDING, BUT NOT LIMITED TO, ANY CLAIMS FOR LOSS OF PROFITS. SOME JURISDICTIONS DO NOT ALLOW THE EXCLUSION OR LIMITATION OF INCIDENTAL OR CONSEQUENTIAL DAMAGES, SO THE FOREGOING LIMITATION OR EXCLUSION MAY NOT APPLY TO YOU. THIS WARRANTY AND THE REMEDIES SET FORTH ARE EXCLUSIVE AND IN LIEU OF ALL OTHER WARRANTIES, REMEDIES AND CONDITIONS, WHETHER WRITTEN, ORAL, STATUTORY OR IMPLIED. TO THE EXTENT PERMITTED BY LAW, KIRBRE DISCLAIMS ANY IMPLIED WARRANTIES, INCLUDING WITHOUT LIMITATION ANY IMPLIED WARRANTY OF MERCHANTABILITY OR FITNESS FOR A PARTICULAR USE OR PURPOSE; TO THE EXTENT SUCH DISCLAIMER IS NOT PERMITTED BY LAW, SUCH IMPLIED WARRANTIES ARE LIMITED TO THE DURATION OF THE APPLICABLE EXPRESS WARRANTY AS DESCRIBED ABOVE. SOME STATES AND PROVINCES DO NOT ALLOW LIMITATIONS ON HOW LONG AN IMPLIED WARRANTY LASTS, SO THE ABOVE LIMITATION MAY NOT APPLY TO YOU, THIS WARRANTY GIVES YOU SPECIFIC LEGAL RIGHTS, AND YOU MAY ALSO HAVE OTHER RIGHTS WHICH VARY FROM STATE TO STATE AND PROVINCE TO PROVINCE.



General Disclaimer:

While Onefinity has made every effort at the time of publication to ensure the accuracy of the information provided herein, product specifications, configurations, system/component/options availability are all subject to change without notice. Product design specifications and colours are subject to change without notice and may vary from those shown. Errors and omissions excepted. Images displayed are for illustration purposes only. The images are intended to help illustrate the product and its functions and are not indicative of actual relative differences.

www.onefinitycnc.com

Email: info@onefinitycnc.com or Call: 1 888 717 4242



General Disclaimer:

While Onefinity has made every effort at the time of publication to ensure the accuracy of the information provided herein, product specifications, configurations, system/component/options availability are all subject to change without notice. Product design specifications and colours are subject to change without notice and may vary from those shown. Errors and omissions excepted. Images displayed are for illustration purposes only. The images are intended to help illustrate the product and its functions and are not indicative of actual relative differences.